

|     |            |    |      |             |
|-----|------------|----|------|-------------|
| REV | DATE       | BY | CHKD | DESCRIPTION |
| 1   | 07/20/2006 | PA |      | 14 Inch     |
| 2   |            |    |      |             |
| 3   |            |    |      |             |
| 4   |            |    |      |             |
| 5   |            |    |      |             |
| 6   |            |    |      |             |
| 7   |            |    |      |             |
| 8   |            |    |      |             |
| 9   |            |    |      |             |
| 10  |            |    |      |             |

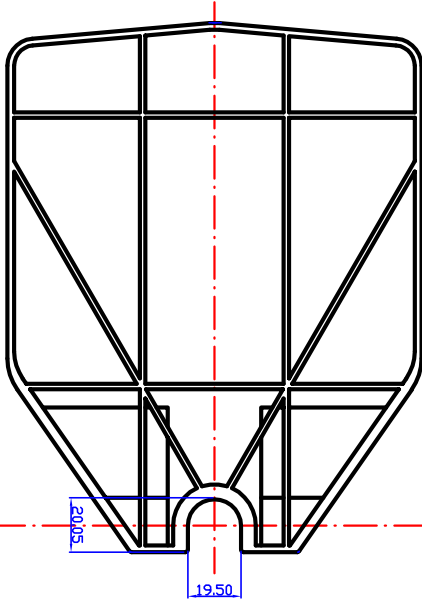

|     |          |    |      |             |
|-----|----------|----|------|-------------|
| REV | DATE     | BY | CHKD | DESCRIPTION |
| 1   | 02/07/04 |    |      | 2004        |
| 2   |          |    |      |             |
| 3   |          |    |      |             |
| 4   |          |    |      |             |
| 5   |          |    |      |             |
| 6   |          |    |      |             |
| 7   |          |    |      |             |
| 8   |          |    |      |             |
| 9   |          |    |      |             |
| 10  |          |    |      |             |
| 11  |          |    |      |             |
| 12  |          |    |      |             |
| 13  |          |    |      |             |
| 14  |          |    |      |             |
| 15  |          |    |      |             |
| 16  |          |    |      |             |
| 17  |          |    |      |             |
| 18  |          |    |      |             |
| 19  |          |    |      |             |
| 20  |          |    |      |             |
| 21  |          |    |      |             |
| 22  |          |    |      |             |
| 23  |          |    |      |             |
| 24  |          |    |      |             |
| 25  |          |    |      |             |
| 26  |          |    |      |             |
| 27  |          |    |      |             |
| 28  |          |    |      |             |
| 29  |          |    |      |             |
| 30  |          |    |      |             |
| 31  |          |    |      |             |
| 32  |          |    |      |             |
| 33  |          |    |      |             |
| 34  |          |    |      |             |
| 35  |          |    |      |             |
| 36  |          |    |      |             |
| 37  |          |    |      |             |
| 38  |          |    |      |             |
| 39  |          |    |      |             |
| 40  |          |    |      |             |
| 41  |          |    |      |             |
| 42  |          |    |      |             |
| 43  |          |    |      |             |
| 44  |          |    |      |             |
| 45  |          |    |      |             |
| 46  |          |    |      |             |
| 47  |          |    |      |             |
| 48  |          |    |      |             |
| 49  |          |    |      |             |
| 50  |          |    |      |             |

16 Inch

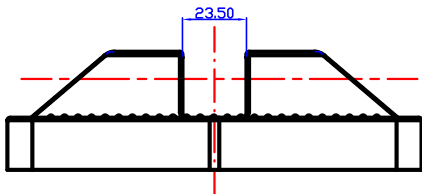
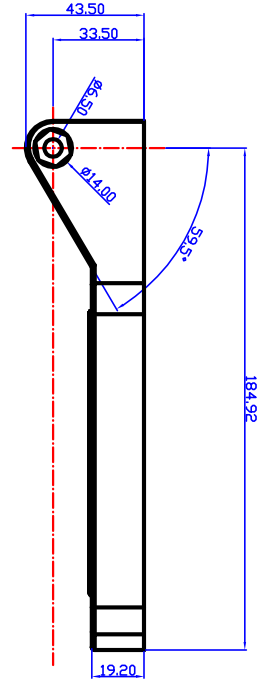
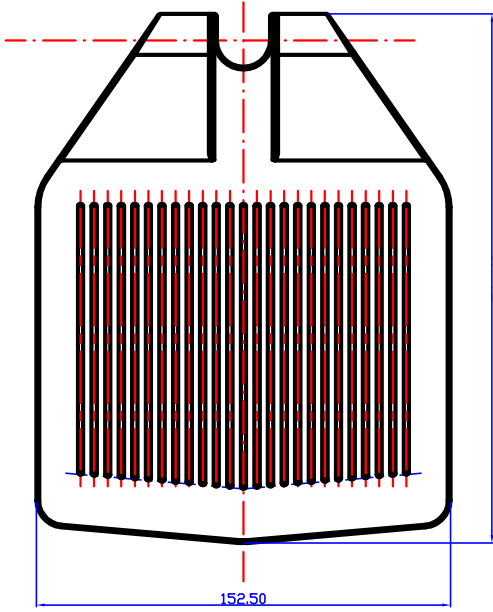
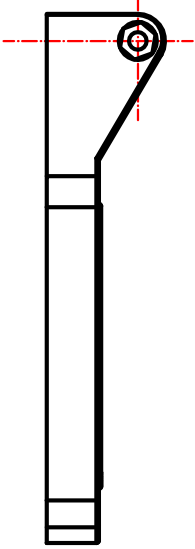
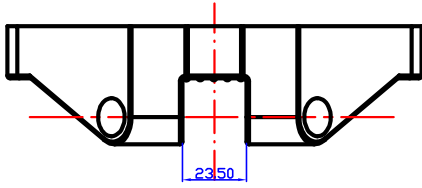
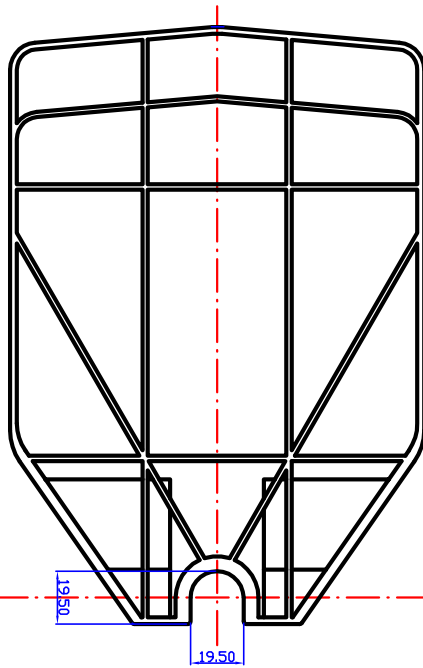
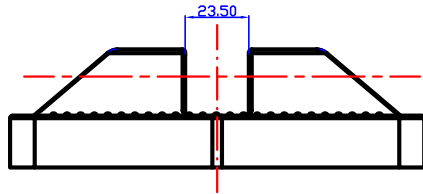
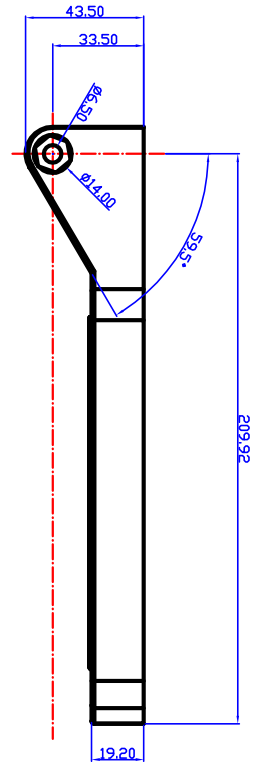
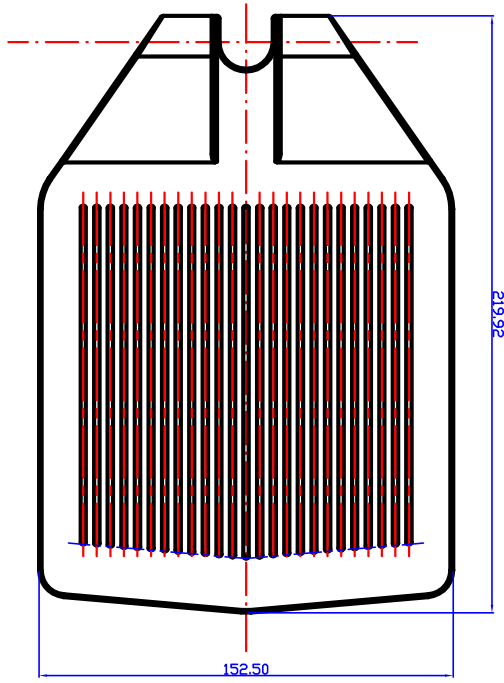
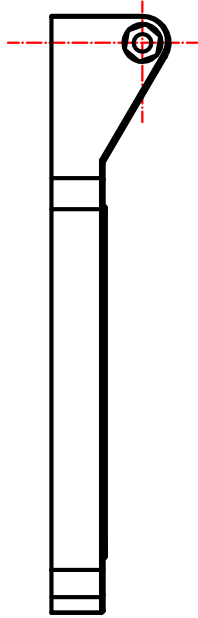
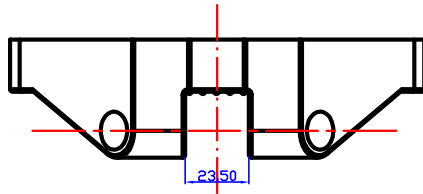

|                |            |    |      |      |
|----------------|------------|----|------|------|
| REV            | DATE       | BY | CHKD | APPD |
| 1              | 07/20/2006 |    |      |      |
| <p>18 Inch</p> |            |    |      |      |