



*CATALOG*

**rIFEITENG**

---

*[www.rifeiteng.com.tw](http://www.rifeiteng.com.tw)*



ABOUT

# RI FEI TENG Co., LTD

Since 1995, RI FEI TENG has been committed to plastic injection, mold design and development.

In 2015, a PU foaming factory was opened. Mainly supplies wheels for assistive devices.

Now, we are still developing new products and also accept OEM/ODM.

Made in TAIWAN



# TABLE OF CONTENTS

<b>Polyurethane Tire with Aluminum - Soft Roll Caster Series.....</b>	<b>2</b>
<b>Polyurethane Tire with Plastic Rim - Soft Roll Caster Series.....</b>	<b>3</b>
<b>PU And Rubber Tire With Brake Series.....</b>	<b>4</b>
<b>Polyurethane Tire with Plastic Rim Series.....</b>	<b>5.6.7</b>
<b>PU Solid Wheel - Outdoor Sport Series- Electric Wheelchair/ Mobility Scoot .....</b>	<b>8.9.10</b>
<b>PU Solid Tire -Manual Rear Wheel Series.....</b>	<b>11</b>
<b>Other Wheels Types.....</b>	<b>12.13</b>
<b>Forks - Aluminum Standard Type.....</b>	<b>14</b>
<b>Forks - Plastic Standard Version Type.....</b>	<b>15</b>
<b>Wheelchair parts.....</b>	<b>16.17</b>
<b>Accessories.....</b>	<b>18</b>
<b>Soft Caster For Office Chair.....</b>	<b>19</b>

# Polyurethane Tire with Aluminum - Soft Roll Caster Series

## W335 - 3" x 1.4"



3.0"



1.4"



1.0"



0.3"(8.0mm)



688



110lb/50kg

Rim Color Available :

Anodizing- Silver / Black / Red / Blue / Green / Gold /purple

## W435 - 4" x 1.4" / W425 - 4" x 1.0"



4.0"

4.0"



1.4"

1.0"



1.0"

1.0"



0.3"(8.0mm)

0.3"(8.0mm)



608

608



110lb/50kg

110lb/50kg



Rim Color Available :

Anodizing - Silver / Black / Red / Blue / Green / Gold /purple

Coating - White

## W535 - 5" x 1.4" / W525 - 5" x 1.0"



5.0"

5.0"



1.4"

1.0"



1.0"

1.0"



0.3"(8.0mm)

0.3"(8.0mm)



608

608



110lb/50kg

110lb/50kg

Rim Color Available :

Anodizing - Silver / Black / Red / Blue / Green / Gold /purple

Coating - White

## W635 - 6" x 1.4"



6.0"



1.4"



1.0"



0.3"(8.0mm)



608

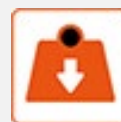

110lb/50kg



Rim Color Available :

Anodizing - Silver / Black / Red / Blue / Green / Gold /purple

Coating - White

# Polyurethane Tire with Plastic Rim - Soft Roll Caster Series



W434 - 4" x 1.4"



4.0"



1.4"



1.0"



0.3"(8.0mm)



608



110lb/50kg

Rim Color : Black

2024 NEW PRODUCT

W534 - 5" x 1.4"



5.0"



1.4"



1.0"



0.3"(8.0mm)



608



110lb/50kg

Rim Color : Black



2024 NEW PRODUCT

W634 - 6" x 1.4"



6.0"



1.4"



1.0"



0.3"(8.0mm)



608



110lb/50kg

Rim Color : Black

2024 NEW PRODUCT

# 各式煞車輪



## 7 或 8 吋PU胎鼓煞輪



7.0"  
8.0"



1 1/4"  
1 1/4"

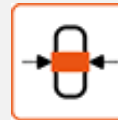

40mm  
40mm



0.3"(8.0mm)  
0.3"(8.0mm)



608  
608



110lb/50kg  
110lb/50kg

Spoke Available : 7

2024 NEW PRODUCT

## 10吋橡膠胎碟煞輪



10"



2.125"



89mm



12mm



6001



110lb/50kg



2024 NEW PRODUCT

## 12吋橡膠胎碟煞輪



12.0"



1.4"



70mm



12mm



6001



110lb/80kg

Rim Color : Black

2024 NEW PRODUCT

# Polyurethane Tire with Plastic Rim Series



## W514 - 5" x 1 1/4"



5.0"  
5.0"



1 1/4"  
1 1/4"



42mm  
33mm



0.3"(8.0mm)  
0.3"(8.0mm)



608  
608

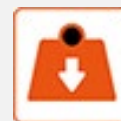

110lb/50kg  
110lb/50kg

## W614 - 6" x 1 1/4"



6.0"



1 1/4"



42mm



0.3"(8.0mm)



608



110lb/50kg



## W714 - 7" x 1 1/4"



7.0"  
7.0"



1 1/4"  
1 1/4"



40mm  
60mm



0.3"(8.0mm)  
0.3"(8.0mm)



608  
608



110lb/50kg  
110lb/50kg

Spoke Available : 5 or 7

## W814 - 8" x 1 1/4"



8.0"  
8.0"



1 1/4"  
1 1/4"



40mm  
60mm



0.3"(8.0mm)  
0.3"(8.0mm)



608  
608



110lb/50kg  
110lb/50kg

Spoke Available : 5 or 7



# Polyurethane Tire with Plastic Rim Series



W105 - 10" x 1.3"



10"



1.3"



54mm



0.47"(12mm)



6201

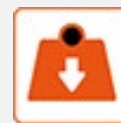

110lb/50kg

W1275 - 12" x 1.6" TYPE - A



12"



1.6"



54mm



0.47"(12mm)



6201



110lb/50kg



W1275 - 12" x 1.6" TYPE - B



12"



1.6"



54mm



0.47"(12mm)



6201

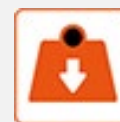

110lb/50kg

W1475 - 14" x 1.4"



14"



1.6"



55mm



0.47"(12mm)



6001



110lb/50kg





# Polyurethane Tire with Plastic Rim Series



W1675 - 16" x 1.3"



16"



1.6"

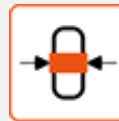

58mm



0.47"(12mm)



6001



110lb/50kg

W1875 - 12" x 1.6" TYPE - A



18"



1.6"



50mm



0.47"(12mm)



6001

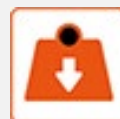

110lb/50kg



# PU Solid Wheel - Outdoor Sport Series- Electric Wheelchair/ Mobility Scoot



RN6U - 150 \* 45



150mm



45mm

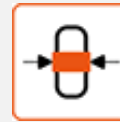

38mm  
40mm  
51mm



8mm  
12mm  
8mm



608  
6001  
608



110lb/50kg

RN6S - 150\*40



150mm



40mm



38mm  
40mm  
51mm



8mm  
12mm  
8mm



608  
6001  
608



110lb/50kg



RN7S - 150 \* 45



175mm



45mm



38mm  
40mm  
51mm



8mm  
12mm  
8mm



608  
6001  
608



110lb/50kg



RN7C - 175\*45



175mm



45mm



38mm  
40mm  
51mm



8mm  
12mm  
8mm



608  
6001  
608

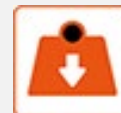

110lb/50kg



# PU Solid Wheel - Outdoor Sport Series- Electric Wheelchair/ Mobility Scoot



RN8S - 200 \* 50



200mm



50mm

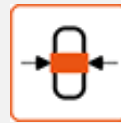

40mm  
60mm  
60mm  
55mm



12mm  
12mm  
8mm  
17mm



6201  
6201  
608  
6903



110lb/50kg

RN8F - 200\*70



200mm



70mm



40mm  
60mm  
60mm  
55mm



8mm  
12mm  
8mm



608  
6001  
608



110lb/50kg



RN8U - 200\*50



200mm



50mm



40mm  
60mm  
60mm  
55mm



12mm  
12mm  
8mm  
17mm



6201  
6201  
608  
6903



110lb/50kg



RN8U - 200\*60



200mm



60mm



40mm  
60mm  
60mm  
55mm



12mm  
12mm  
8mm  
17mm



6201  
6201  
608  
6903

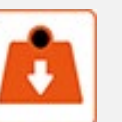

110lb/50kg



# PU Solid Wheel - Outdoor Sport Series- Electric Wheelchair/ Mobility Scoot



RN - 2.80/2.50 - 4



220mm



71mm



40mm  
60mm  
60mm  
55mm



12mm  
12mm  
8mm  
17mm



6201  
6201  
608  
6903



110lb/50kg

RN9U - 225\*55



225mm



55mm

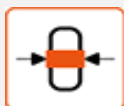

40mm  
60mm  
60mm  
55mm



12mm  
12mm  
8mm  
17mm



6201  
6201  
608  
6903



110lb/50kg



# PU Solid Tire -Manual Rear Wheel Series

## 16 & 24 inch Outdoor Tread

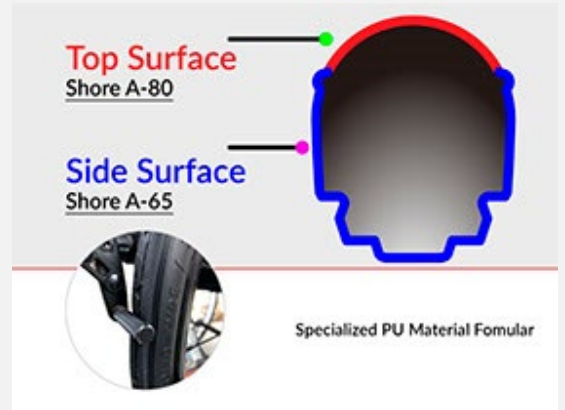

## 20 / 22 / 24 inch Standard

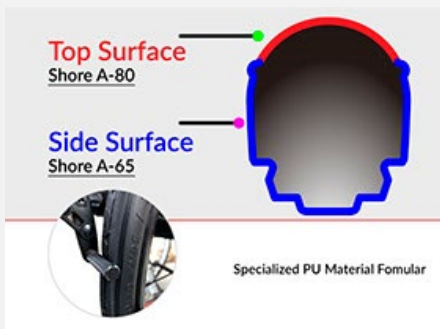

# Other Wheels Types



Mode No.	mm	mm	mm	mm	code
WS – 524	124.5	22.6	27.4	8	✘
WS – 321	80	24	24	8	608
WS – 301	75	24	24	8	608
WS – 288	70	20	24	8	608
WS -271	68	24	24	8	608
WS – 241	60	24	24	8	608
WS – 211	55	24	24	8	608
WS – 209	50	23	24	8	608
WS – 208	50	20	23.5	6.4	✘

# Other Wheels Types

## AGV Wheel

### Customized AGV Special Wheel

Tire :Casting Polyurethane  
advantage :

- Antistatic
- High Load

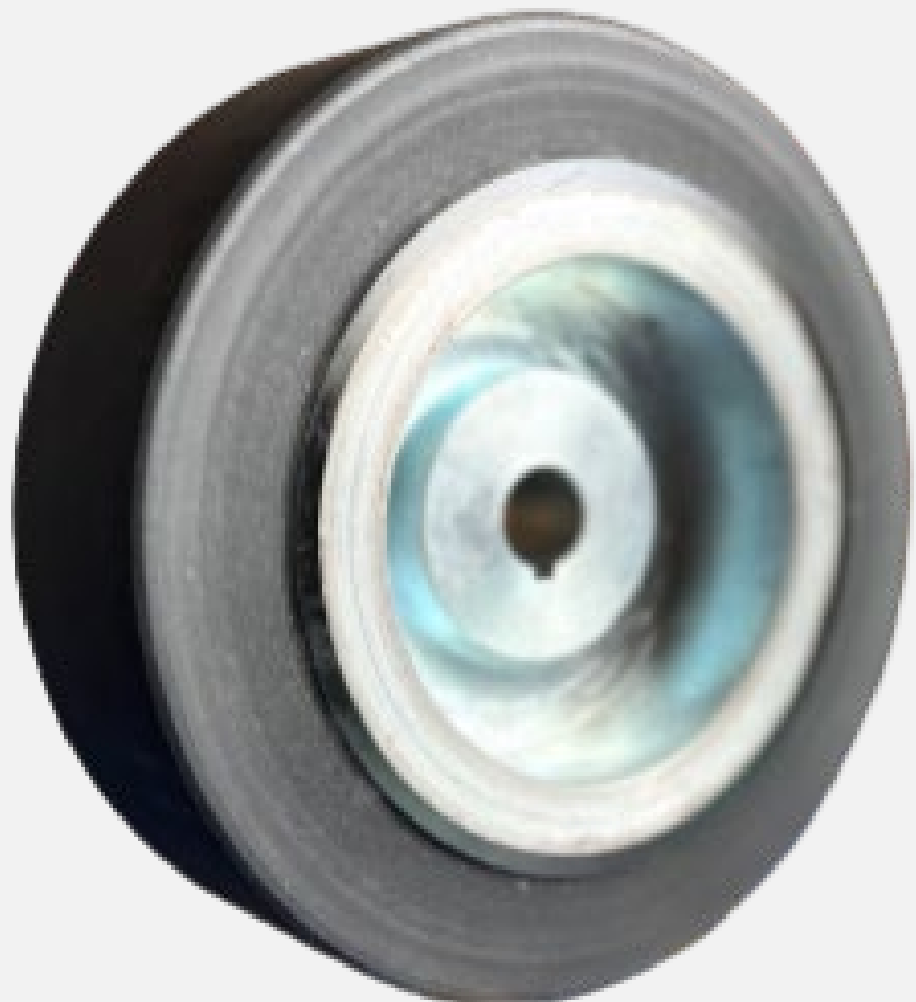

# Forks - Aluminum Standard Type

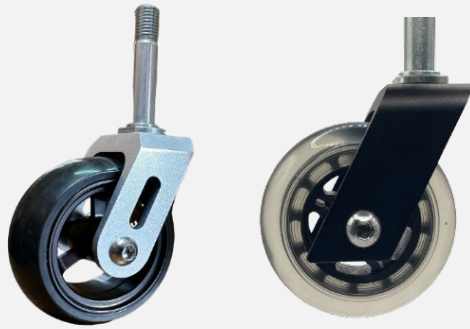

## K451 - ASW

Suggest Wheels Used : 3" or 75mm The Following

Material : Aluminum 6061 T6

With Bearing : R8

Surface Treatment : Anodic

Vertical Axis : M12 / Can Be Customized

2024 NEW PRODUCT

## FK12 - ASW

Suggest Wheels Used : 3", 4", 5", 6"

Material : Aluminum 6061 T6

With Bearing : R8

Surface Treatment : Anodic

Vertical Axis : M12 / Can Be Customized

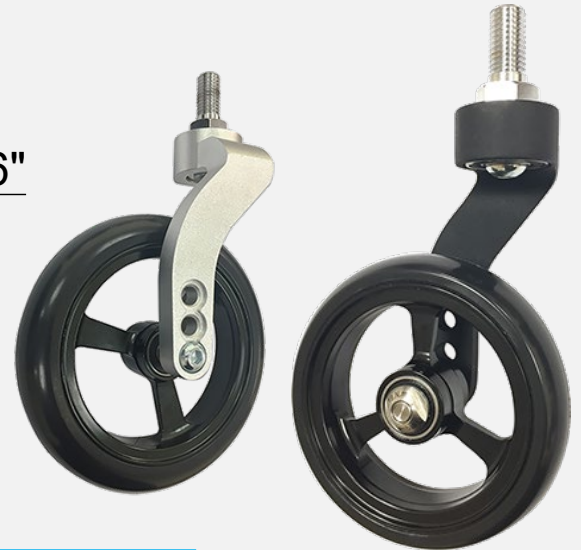

## FK458 - ASW

Suggest Wheels Used : 3", 4", 5", 6"

Material : Aluminum 6061 T6

With Bearing : R8

Surface Treatment : Anodic

Vertical Axis : M12 / Can Be Customized

## FK488 - ASW

Suggest Wheels Used : 3", 4", 5", 6"

Material : Aluminum 6061 T6

With Bearing : R8

Surface Treatment : Anodic

Vertical Axis : M12 / Can Be Customized





# Forks - Plastic Standard Version Type



## FK64 - 6 inch

Suggest Wheels Used : 5, 6, inch

Suggest Axis Distance : 40 mm

Material: PA6 + GF 20%

Bearing : 6001

Vertical Axis : M12 / Customized

## FK64 EX - 6 inch

Suggest Wheels Used : 5 , 6 inch

Suggest Axis Distance : 40 mm

Material: PA6 + GF 20%

Bearing : 6001

Vertical axis : M12 / Customized



## FK74 - 7 inch

Suggest Wheels Used : 5, 6, 7 inch

Suggest Axis Distance : 40 mm

Material: PA6 + GF 20%

Bearing : 6001

Vertical Axis : M12 / Customized

## FK84 - 8 inch

Suggest Wheels Used : 5, 6, 7, 8 inch

Suggest Axis Distance : 40 mm

Material: PA6 + GF 20%

Bearing : 6001

Vertical Axis : M12 / Customized



## FK86 - 8 inch

Suggest Wheels Used : 5, 6, 7, 8 inch

Suggest Axis Distance : 60 mm

Material: PA6 + GF 20%

Bearing : 6001

Vertical Axis : M12 / Customized

# Wheelchair parts



## WH-1511

Suitable For The Wheelchair 1" & 7/8" Tube.

Material :

- PA6+GF20%
- Aluminum 6061

### Model / Dimension "A"

- NF - 10 / 10 inch
- NF - 12 / 12 inch
- NF - 14 / 14 inch
- NF - 16 / 16 inch



### Model / Dimension "A"

- XF - 16 / 16 inch
- XF - 18 / 18 inch
- XF - 20 / 20 inch

### Model / Dimension "A"

- MF - 14 / 14 inch
- MF - 16 / 16 inch
- MF - 18 / 18 inch



## RF-03 / 04 /05



Fixed Wheelchair Pedal  
Customized

Material : Aluminum 6061 / T6  
surface: Sand Blasted Anode

# Wheelchair parts



## LA - 25 / 26 Arm Rest

Material:

- ABS + Flame Retardant PVC forming (1.0mm Black cover).

- 3 Stuff Types Available

- 1.EVA

- 2.HR

- 3.Sponge

2 types of holes, M5 screws Brass Nut Pre-Insert.

## FW - 10 Leg Rest

Material :

- ABS + Flame Retardant PVC forming (1.0mm Black cover).

M6 \* 4 screws Brass Nut Insert.



## Spacer

**RS - 19B( M6 Hole)**

Suitable Diameter : 19 mm

**RS - 16B ( M6 Hole)**

Suitable Diameter : 16 mm

Material :

- PA6



# Accessories



## Walker Wheels - Replacement Feet

Material :

- Aluminum Tube - Diameter 1.1"
- Suitable for 1.0" tube.
- PVC high quality 5" Wheel with Nylon Rim

## Rollator Screw

R - 714 ( M6 )

Screw Length Changeable

Material :

- ABS+PC+M6 Screw



## Sock Wear Aids

Material:

- PP
- Nylon Belt

Instructions:

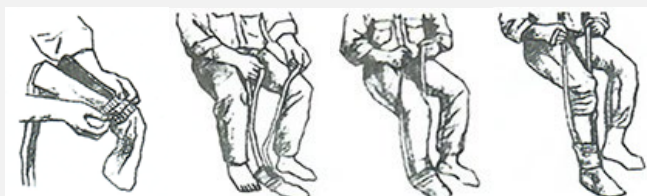

# Soft Caster For Office Chair

**NEW !**

Any surface easy, quiet & smooth rolling  
 Don't mark, stain & scratch for your floor  
 Safe for all floors  
 Unique & stylish  
 Smooth & quiet rolling  
 Easy Clean  
 Easy Install  
 Bearing beads won't fall off



Passed the test "ANSI / BIFMA X5.1-2017 Clause 16.1"  
 Load capacity 270 lbs (122kg)

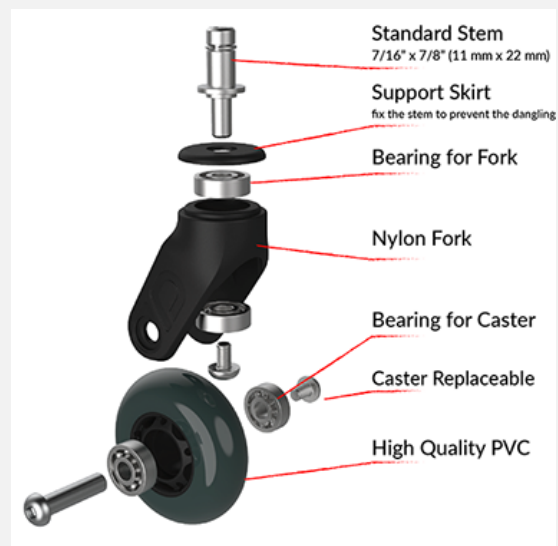

Specifications	Descriptions
Origin Country	Design & Made in Taiwan
Material of Caster	High Quality PVC
Material of rim	Nylon(PA6)
Material of Fork	Nylon(PA6)
Material of Stem Bolt	Steel with plating (anti-rust)
Screws	Steel with Nylok (Fall resistance)
Test pass BIFMA	Yes (ANSI / BIFMA X5.1-2017 Clause 16.1)
Bearing	2 sets on fork & casters
Fade	none
Color of Fork	Black
Color of Caster	Black rim & Deep Green Tire*1 (Tire color can be Customized)
Dimension	Refer the Drawing

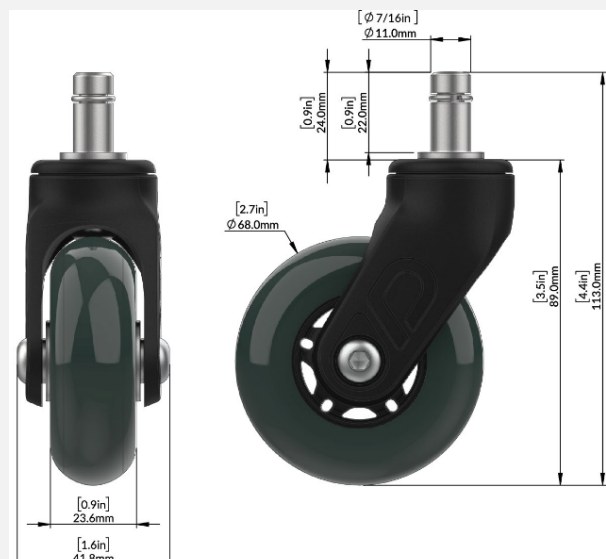

**RIFEITENG**

---

No. 161, Wugu Road, Sankanli, Waipu District, Taichung City, Taiwan  
TEL: +886 - 426839378  
FAX: +886 - 426839321